

1800/1850 SERIES LINEAR BAR GRILLE

FLOOR / SILL APPLICATION

FRAMES H, M, N

SUBMITTAL SHEET

NOTES :

1. Widths run from 2" to 12" in 1/4" Increments.
2. The Minimum Length is 6". The Maximum Length of One Section is 6'-0" Overall. Sections can be Spliced together with Alignment Brackets, See Form GS0310
3. Width = Ordered Width = _____
4. Length = Ordered Length = _____
5. Units May be Used for Either Supply or Return Applications.
6. Construction is Extruded Aluminum with Steel Fasteners.
7. Standard Finishes are 10 Alumican or 44 British White.
8. Lay in Core is not attached and ships separately.
9. Width > 10" is not recommended for floor use.

OPTIONAL ACCESSORIES:

- See Form GS0312 For:
- Dampers
 - Linear Straightening Grid
 - Blank-Off Strips
 - Core Clips
 - Snap Clips
- See Form GS0309 For:
- Mitered Corners

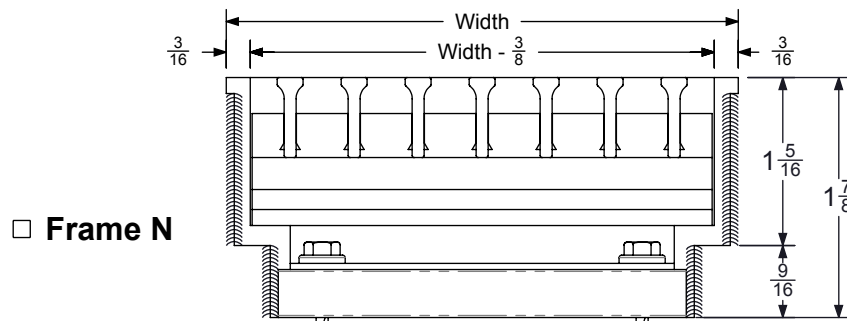
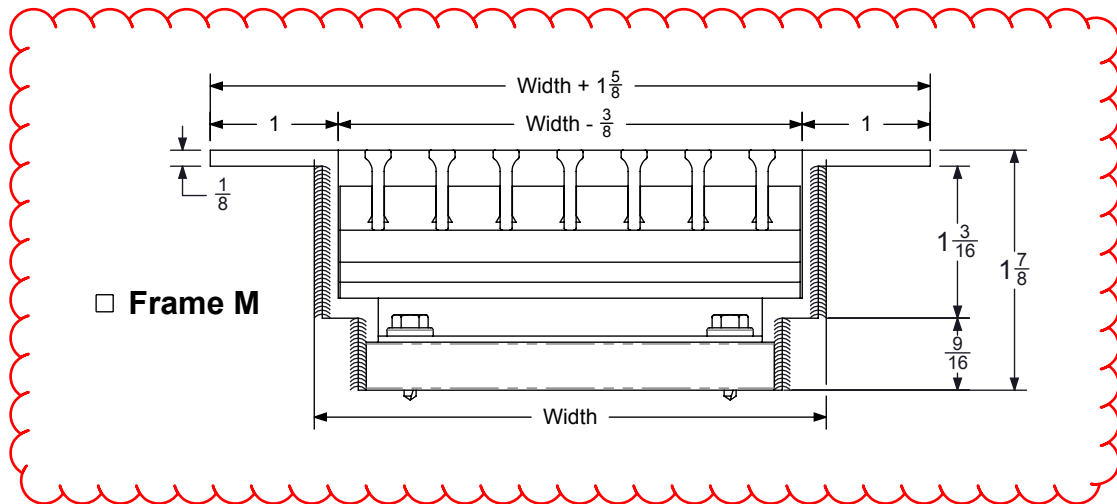
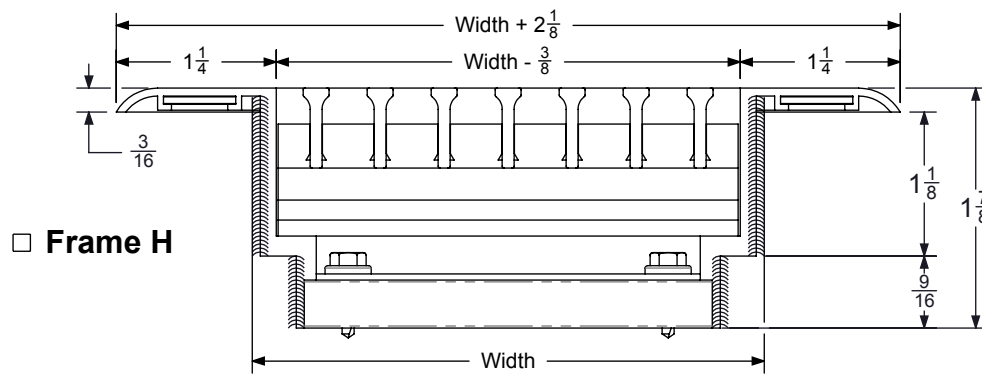

1800/1850 SERIES LINEAR BAR GRILLE

FLOOR / SILL APPLICATION

FRAMES H, M, N

JOB NAME _____
 ENGINEER _____
 CONTRACTOR _____
 TAG _____

SUBMITTAL SHEET

*ALIGNMENT TABS AND BRACKETS ARE ONLY INCLUDED ON ORDERS OVER 72" IN LENGTH

*MAX BLADE SUPPORT BAR SPACING IS 6"

FRAME STYLE	FLANGE F	O.A. FACE		ALIGNMENT BRACKET
		(1) END CAP	(2) END CAPS	
H	1 1/4	LENGTH + 1 1/16	LENGTH + 2 1/8	730495
M	1	LENGTH + 13/16	LENGTH + 1 5/8	730495
N	3/16	LENGTH	LENGTH	730495

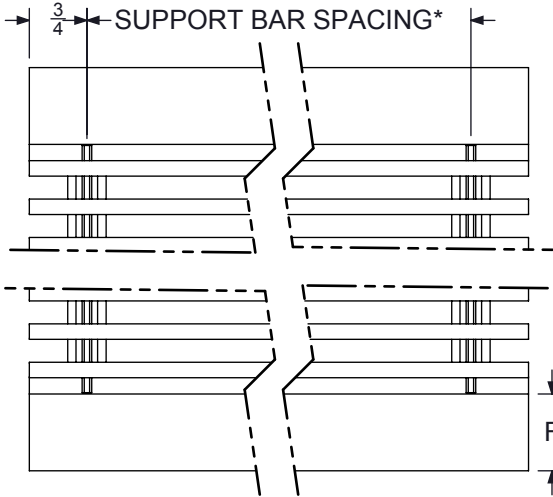

□ BUTT CUT

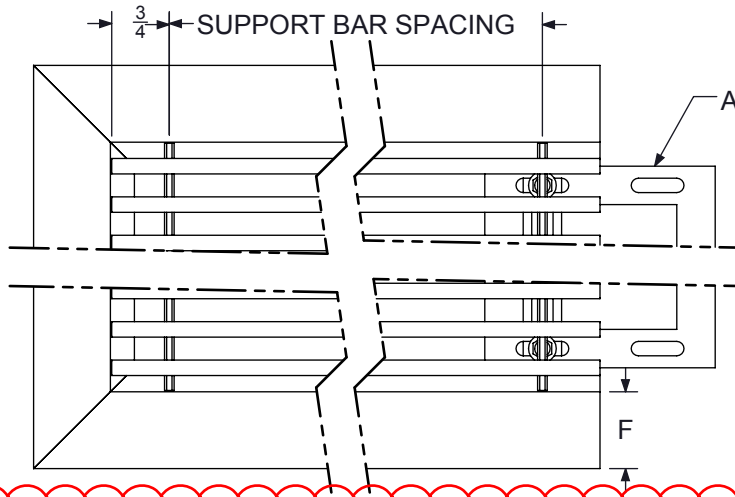
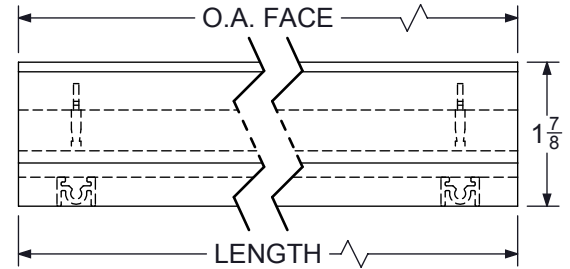

□ (1) END CAP

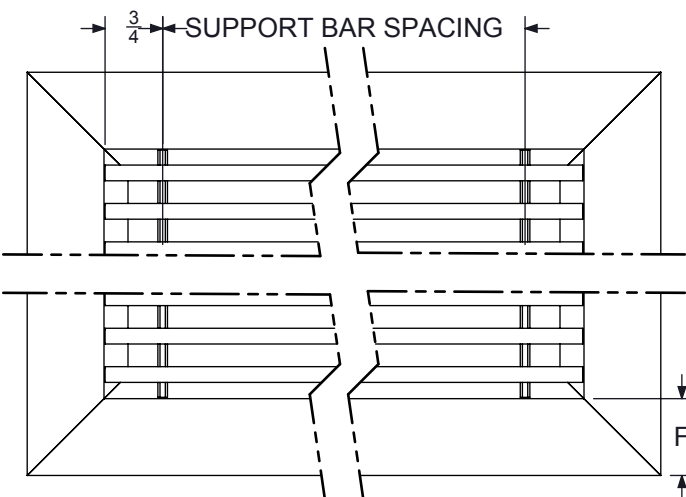
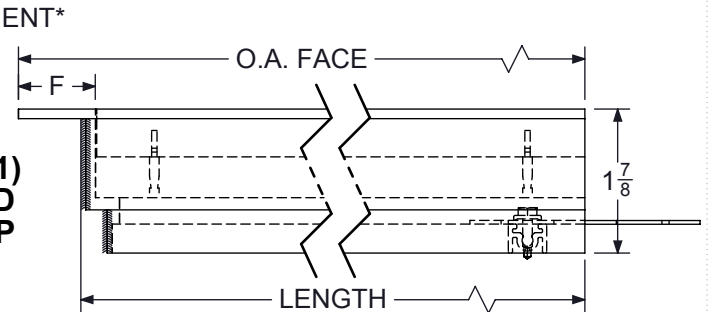

□ (2) END CAPS

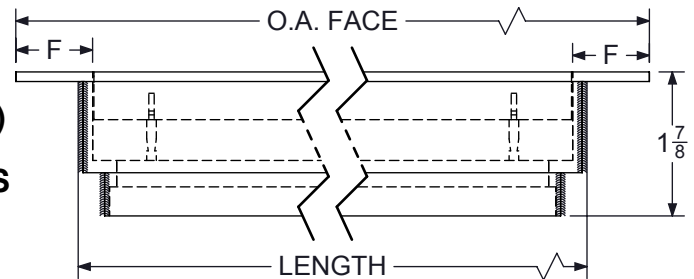

1800/1850 SERIES LINEAR BAR GRILLE

FLOOR / SILL APPLICATION
FRAMES H, M, N

JOB NAME _____
ENGINEER _____
CONTRACTOR _____
TAG _____

SUBMITTAL SHEET

